

# SERAX

Sophie Casier

OYA 01

TABLE LAMP

MOUNTING INSTRUCTION MANUAL

B0422010

B0422011

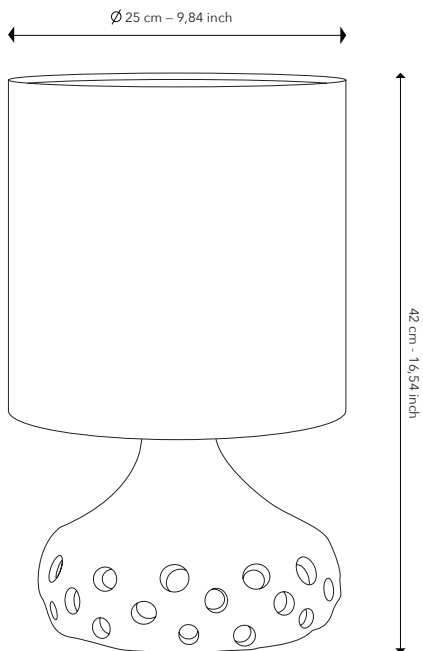

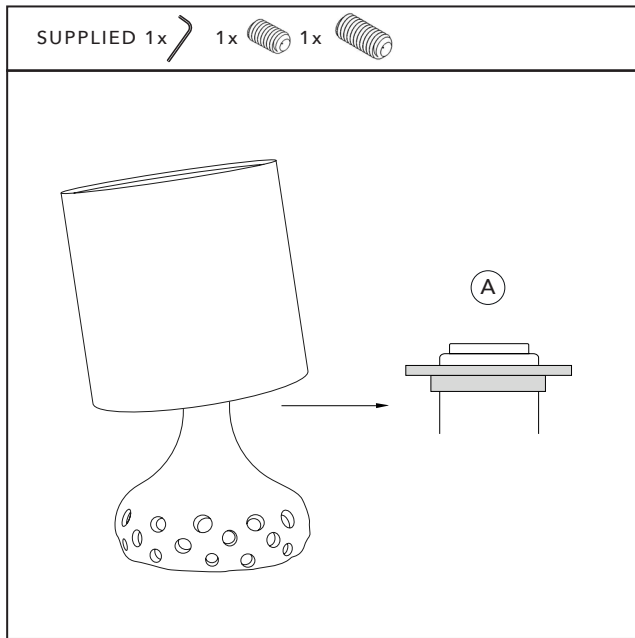

**1.**

When the lampshade is not levelled (90°), see step 2 to correct this.

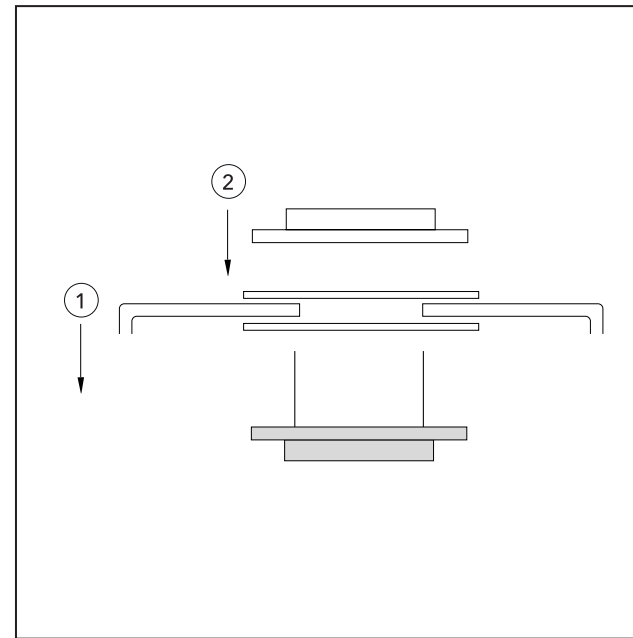

**3.**

Place the lampshade on the frame (1) and fix with the second socketring on top. (2)

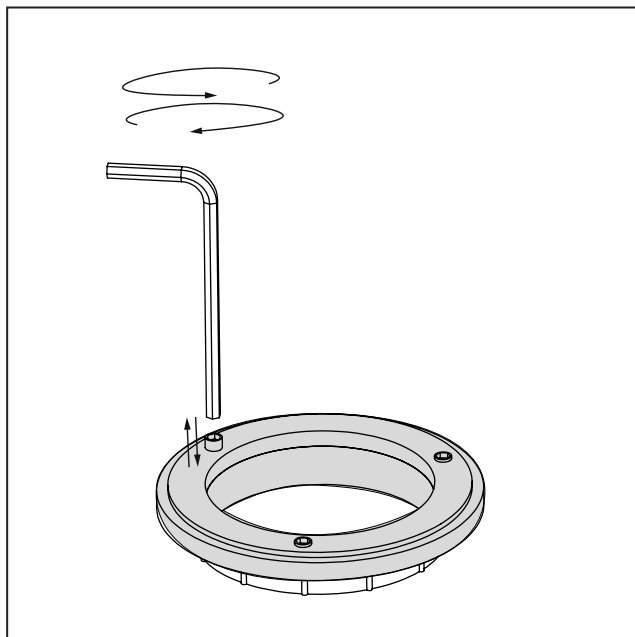

**2.**

Details of step A:

To level the lampshade, adjust the screws with the provided hexagon-key. 

If levelling is not yet successful, use the longer provided screws.

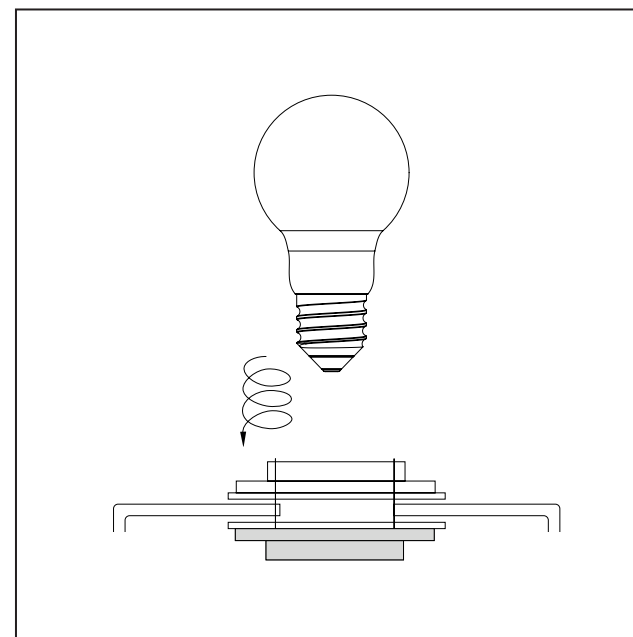
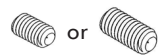

**4.**

Screw in the light bulb.

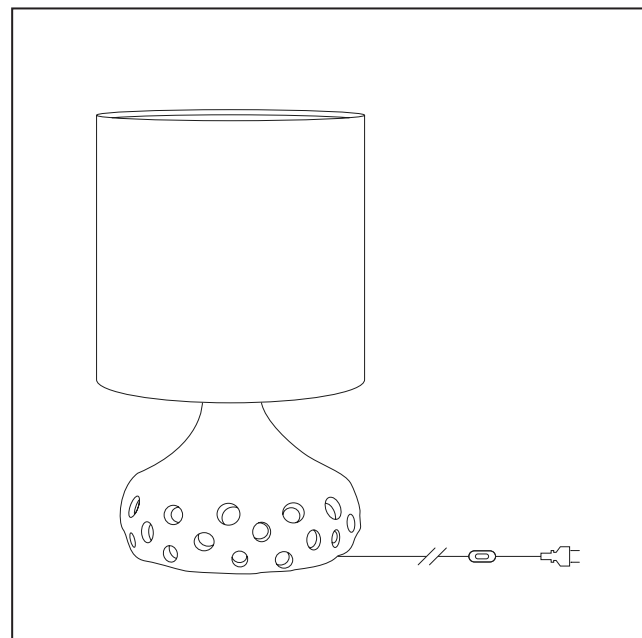

**5.**

Now the lampshade is horizontal.

## LUMINARY SPECS













TYPE	Table Lamp
COLOURS	Brown & beige
MATERIAL	Ceramic & textile
DIMENSIONS	L25 W25 H42 cm L9,84 W9,84 H16,54 inch
WEIGHT	3,28kg
SWITCH	Handswitch
DIMMABLE	No
CABLE LENGTH	1,5 m
BULB TYPE	E27 (in the top of the lamp) E14 (at the bottom of the lamp)
LIGHTBULB INCLUDED	No
MAXIMUM VOLTAGE	240 Volt
MAXIMUM WATTAGE	5 W
CLASS	II
ENVIRONMENT	IP20

## SAFETY DIRECTIONS

Please study the instruction manual and below information carefully before installing or using this product and keep this user manual for further reference.

1. The luminaires may only be installed by authorized and qualified technicians according the valid regulations for electrical installation.
2. Maintenance of the luminaires is limited to their surfaces. During maintenance no moisture can come into contact with any areas of the terminal connections or voltage control parts.
3. The electrical supply must be switched off at the outset, preferably by means of a switch in the distribution box, before any installation, maintenance or repair work is undertaken.
4. Exterior light must not be installed during rain.
5. Take account of the minimal separation distance from other objects and the room required around the fitting.
6. If in any doubt, consult a professional, taking local installation requirements into account. Some countries stipulate that lighting may be installed only by registered installers.
7. Clamping screws in electrical connections must be adequately tightened. This is particularly the case with 12V low voltage conductors.
8. When replacing a halogen lamp, wait for it to cool, for a minimum of 5 minutes.
9. Clean with a clean, dry cloth or brush, use no solvents or abrasives. Avoid dampness on all electrical components.
10. Take account of all available technical information.
11. Take note of the symbols when connecting wires:
  - N = Neutral
  - L = Live
  -  = Earth
12. If the external flexible cable or cord of this luminaire is damaged, it shall be exclusively replaced by the manufacturer or his service agent or a similar qualified person in order to avoid a hazard.

## SYMBOLS & MEANINGS

-  For indoor use only, where direct contact with water is impossible.
-  Protection class 1: the fitting must be earthed.
-  Protection class 2: the fitting is double insulated and does not require earthing.
-  Protection class 3: the fitting is low voltage.
-  Observe the indicated minimum distance between the lamp and the illuminated materials/objects.
-  Only the self-screening halogen illuminants should be used with the luminaire.
-  Strip the wire to the indicated length.
-  Connect using the specified cable.
-  The fixture can be used in combination with a dimmer. Consult the sales outlet for the correct type of dimmer (important in the case of 12V fittings)
-  The maximum wattage indicated in each lighting unit, for example, must not be exceeded.
-  This luminaire cannot be disposed together with normal domestic waste, you have to bring it to a staging area for electrical waste.
-  This luminaire was designed to work only with the indicated voltage.
-  This shows that the products meets EU safety, health or environmental requirements.

SYMBOLS FOR THIS PRODUCT:



# SERAX

VELDKANT 21, 2550 KONTICH, BELGIUM

SERAX.COM +32 3458 05 82