

Instructions

Solid SC104 Space Copenhagen 2025



Please read these instructions carefully and retain them for future reference to ensure the product is used correctly. For your own safety, please study each step of this instruction manual first. &Tradition is not responsible for any faults or damages caused by not following these instructions correctly. Do not modify this product in any way. If you have any questions or comments, please do not hesitate to contact us via email on: info@andtradition.com

Solid SC104 Space Copenhagen 2025

Safety precautions

- Dispose of plastic bag from packaging and do not allow children to play with it.
- Read through the following instructions carefully, before installation.
- If in any doubt, consult a professionally qualified electrician.
- The SC104 model is suitable for both indoor and outdoor use.
- The product should only be installed in the shown orientation.

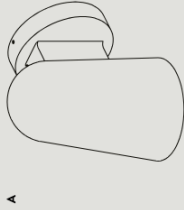

A

Contents

- A Lamp
- B Wall bracket (inc. screws)
- C Terminals x 3
- D Allen key

Tools needed

- GU10 Bulb

Cleaning instructions

Wipe the surface of the shade with a soft, dry cloth. Do not use any abrasive cleaning tools such as steel wool, scouring sponges or stiff brushes as this will damage the surface of the shade. Do not use strong cleaning agents such as white spirit, terpentine, household glass cleaner or cellulose thinners.



B



C

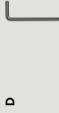

D

Step 1 / 6

Turn off the main electricity supply before installation.

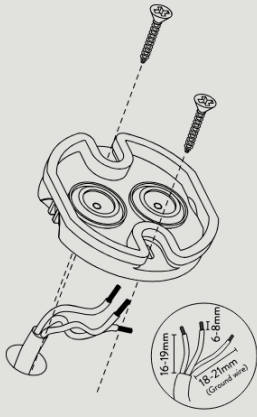

Measure and mark the wall using the screw holes to install the wall bracket (B) as pictured. Notice the cord entry is designed to be offset from the centre of the bracket.

Step 2 / 6

Puncture the membrane on the bracket (B) and insert the cord from the wall only once in order to ensure the membrane stays watertight.

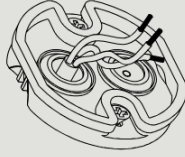

Thread the cord through the membrane so the bracket sits flush against the wall. Secure into place with the pre-installed screws using the Allen key (D) provided.

Step 3 / 6

Use the terminals (C) to connect the lamp cords to the supply cords as shown.

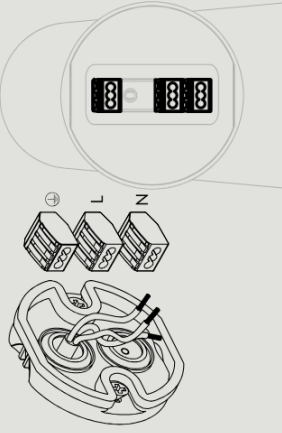

Connect cables to the terminal boxes, use **one** for L to L, N to N and \oplus to \oplus

10/24

For indoor and outdoor use
GU10 maximum 5W (LED only)
Bulb not included

CE UK \oplus IP 44 \boxtimes

&Tradition®

&Tradition®

Step 4 / 6

Align the terminals (C) on the wall bracket (B) with the lamp as pictured.

Secure the lamp onto the wall bracket by fastening the set screws on the top and bottom of the lamp base as pictured.

Make sure that cords are placed where they will not be compressed by the wall bracket (B)

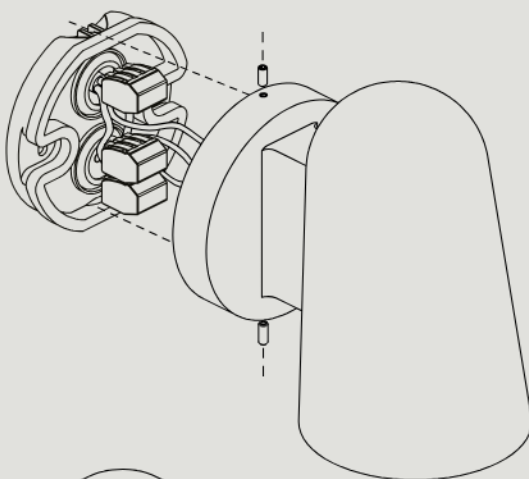

andtradition.com

Step 5 / 6

To install or replace the light source, remove the glass diffuser from the lamp by unscrewing the four screws as shown.

Be careful to hold the diffuser while removing the screws to reduce the risk of breaking the glass.

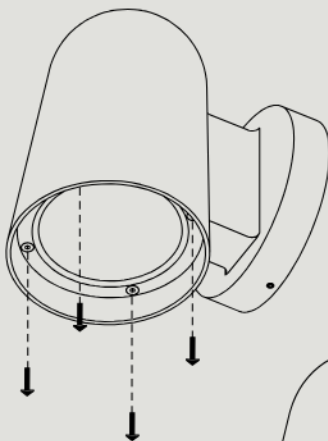

Step 6 / 6

Insert the light source and reinstall the glass diffuser. Make sure to install the silicon element properly to ensure a secure, watertight seal.

The main electricity supply can now be restored.

